

» N_NH series



Mescolatrici planetarie_Planetary mixers_Batteurs mélangeurs_Mezcladores planetarios_Планетарные миксеры

РУССКИЙ ПРОЕКТ
WWW.RP.RU



Mescolatrici
Planetary mixers
Planetary mix
Планетарные миксеры

Mescolatr

www.starmix.it

Mezcladores plane
Batteurs m

Планетарные миксеры

atteurs mélan
Planetary mix
Mescolatrici p

РУССКИЙ ПРОЕКТ
www.rp.ru

planetarie

xers

ici planetarie

etarios

reangeurs

geurs

xers

planetarie

Touch Screen



PL20BNH
15



PL20CNH
17



PL30NH
19



PL40NH
21



PL60NH
23



PL80NH
27



PL80SNH
29



PL100NH
31



PL120NP
33



PL140NP
35



Accessori - Accessories

6

Elettromeccanico

Electromechanical
Électromécanique
Electromecánico
Электромеханическая



PL20BN
39



PL20CN
41



PL30N
43



PL40N
45



PL60N
47



PL80N
51



PL80SN
53



PL100N
55



PL120N
57



PL140N
59



Accessori - Accessories



STARmix
bakery and pastry equipment



Details that make the difference



Made in StarMix
РУССКОЕ ПРОЕКТИРОВАНИЕ
WWW.RP.RU

La nostra azienda

La STARMIX srl nasce nel 1999 nel triangolo industriale Thiene-Marano Vicentino-Schio (Altovicentino), storicamente culla di numerose aziende specializzate nella produzione di macchine e forni per l'arte bianca.

Per l'alta concentrazione territoriale di tali aziende si può senz'altro parlare di distretto industriale Altovicentino delle macchine per prodotti da forno.

La nostra azienda quindi si inserisce e si sviluppa in un contesto territoriale particolarmente favorevole, caratterizzato da una specifica "atmosfera" industriale, carica di professionalità, abilità e tecnologia consolidata, nella quale più facilmente trovano origine idee nuove, ricerche tecnologiche avanzate e si realizza una estesa rete di subfornitori come organizzazione di supporto quanto mai efficace per l'impresa.

In tale contesto la STARMIX si specializza nella produzione di mescolatrici planetarie per pasticceria artigianale e industriale, per il catering e per l'industria cosmetica e farmaceutica e si sviluppa secondo la filosofia dello "step by step" fino a posizionarsi in pochi anni tra le aziende leader del settore. L'ampia gamma di mescolatrici planetarie offerte spazia dai 10 ai 600 litri, con una varietà di caratteristiche e di modelli che soddisfano qualsiasi esigenza.

Our company

STARMIX S.r.l. was founded in 1999 in the industrial area that comprises the towns of Thiene, Marano Vicentino and Schio (in the upper Vicenza province), which is the home of many companies specialized in the productions of machines and ovens for bakeries.

The high concentration of such companies in the area means that we can talk about an "Altovicentino Industrial District" for bakery machines (Upper Vicenza Province Industrial District).

Our company forms an integral and actively growing part of this particularly favourable territorial context, characterised by an industrial environment where professionalism, expertise and a consolidated technological vocation foster new ideas, new state-of-the-art technological research and which also provides a large network of subcontractors that represent a significant support to the company.

STARMIX is specialized in the manufacture of planetary mixers for industrial pastry producers and pastry shops, for the catering sector and for the pharmaceutical and cosmetics industries and has grown in accordance with the "step-by-step" philosophy, quickly becoming one of the leading companies in its sector. The wide range of planetary mixers, from 10 to 600 litres, and the ample choice of features and models can meet the needs of even the most demanding customers.

Notre entreprise

STARMIX srl a été fondée en 1999 dans la région industrielle de Thiene-Marano Vicentino-Schio (au nord de Vicence), berceau historique de nombreuses entreprises spécialisées dans la production de machines et fours pour l'art blanc.

Vue l'haute concentration territoriale de ce genre d'entreprises, l'on peut parler sans aucun doute d'un District industriel du Nord de Vicence des machines pour les produits de boulangerie.

Notre entreprise est donc intégrée et se développe dans un contexte territorial particulièrement favorable, caractérisé par une "atmosphère" industrielle spécifique riche en professionnalisme, habileté et technologie à l'avant-garde, au sein de laquelle de nouvelles idées prennent forme, des recherches technologiquement avancées se déroulent et un grand réseau de sous-traitants se développe et sert de support extrêmement utile pour les entreprises.

Dans ce contexte spécifique, STARMIX se spécialise dans la production de batteurs mélangeurs pour la pâtisserie artisanale et industrielle, pour le catering et pour l'industrie cosmétique et pharmaceutique et se développe selon la philosophie du « pas après pas » jusque à devenir une des entreprises leader dans ce domaine en seulement quelques années. La vaste gamme de batteurs mélangeurs offerte inclut modèles de 10 à 600 litres avec une variété de caractéristiques et de modèles satisfaisant toute exigence.

Nuestra empresa

STARMIX nace en 1999, en el triángulo industrial Thiene-Marano Vicentino-Schio (Alta Provincia de Vicenza), históricamente cuna de numerosas empresas especializadas en la producción de máquinas y hornos para el arte blanco.

Por la alta concentración territorial de estas empresas seguramente podemos hablar de distrito industrial de la Alta Provincia de Vicenza para las máquinas para productos de horno.

Por lo tanto, nuestra empresa se inserta y desarrolla en un contexto territorial especialmente favorable, caracterizado por una "atmósfera" industrial específica, cargada de profesionalismo, habilidad y tecnología consolidada, en que más fácilmente se originan ideas nuevas, investigaciones tecnológicas evolucionadas y se realiza una red extensa de proveedores, como organización de soporte muy efectiva para la empresa.

En este contexto STARMIX se especializa en la producción de mezcladoras planetarias para pastelería artesanal e industrial, para el catering y la industria cosmética y farmacéutica y se especializa siguiendo la filosofía del "paso a paso", hasta posicionarse en pocos años entre las empresas líderes del sector. La amplia gama de mezcladoras planetarias que se ofrecen varía entre los 10 y los 600 litros, con una variedad de características y de modelos que responden a todas las demandas.

Наше предприятие

Предприятие STARMIX основано в 1999 году в крупной промышленной зоне городов Тьене – Марано Вичентино – Скио (Альтовичентино), в которой сконцентрированы многочисленные предприятия, специализирующиеся на производстве оборудования и печей для изготовления хлебобулочных и кондитерских изделий.

Благодаря высокой концентрации в этой зоне описанных выше предприятий, она является промышленным округом района Альтовичентино по производству оборудования для хлебобулочных изделий и выпечки.

Территория, на которой находится наше предприятие, благоприятствует его развитию, так как отличается особенной промышленной «атмосферой», насыщенной профессиональным подходом, навыками и высокими технологиями, где легко воплощать в жизнь новые идеи, использовать новейшие технологические разработки и где находится широкая сеть субподрядчиков, что значительно облегчает работу и увеличивает эффективность предприятия.

Благодаря столь благоприятной атмосфере, предприятие STARMIX, специализирующееся на производстве планетарных миксеров для кондитерской промышленности, для кейтеринга, косметической и фармакологической отраслей и развивающееся согласно философии "step by step", всего за несколько лет заняло позицию лидера в этой отрасли. Широкий ассортимент планетарных миксеров объемом от 10 до 600 литров, отличающаяся различными характеристиками и разнообразием моделей, позволяет удовлетворить любые потребности пользователя.

Mescolatrici planetarie
Planetary mixers
Batteurs mélangeurs
Mezcladores planetarios
Планетарные миксеры



La meccanica

Struttura solida, corretto dimensionamento del sistema di trasmissione, motori potenti e forme degli utensili mescolatori, permettono alle mescolatrici planetarie STARMIX di ottenere una perfetta miscelazione degli impasti per pasticcerie artigianali ed industriali. La trasmissione principale interamente a cinghia garantisce silenziosità e limitata manutenzione nel tempo.

Mechanics

Solid structures, correct transmission system size, powerful motors and the shape of the mixing tools allow STARMIX planetary mixers to obtain the perfect dough mix for pastry shops and industrial pastry producers. The main belt transmission ensures silent operation and limited maintenance operations.

La mécanique

La structure solide, les dimensions appropriées du système de transmission, les moteurs puissants et les formes des outils mélangeurs permettent aux batteurs mélangeurs STARMIX de mélanger les pâtes pour les pâtisseries artisanales et industrielles d'une façon parfaite. Les transmissions principales à courroies garantissent un fonctionnement silencieux et un besoin d'entretien limité dans le temps.

La mecánica

Estructura sólida, dimensionamiento correcto del sistema de transmisión, motores poderosos y formas de las herramientas mezcladoras, permitan a las mezcladoras planetarias STARMIX obtener una mezcla perfecta de las masas para pastelerías artesanales e industriales. La transmisión principal completamente de correa garantiza un bajo nivel de ruido en el tiempo y mantenimiento limitado.

Механическая часть

Прочный и надёжный корпус, оптимальные размеры приводных механизмов, мощные двигатели и оптимальные формы рабочих инструментов планетарных миксеров STARMIX позволяют получить различные полуфабрикаты отличного качества для кондитерской промышленности. Основной привод механизма полностью ременной, гарантирующий бесшумную работу и простое техническое обслуживание.

Gli utensili

Lo speciale sistema di bloccaggio dei fili delle fruste li rende molto più resistenti rispetto alle tradizionali soluzioni esistenti ed allo stesso tempo ne facilita l'eventuale sostituzione. Il raschiatore, disponibile per tutti i modelli a partire dalla 40 litri, è da ritenersi uno strumento indispensabile per ottenere una perfetta omogeneità dell'impasto e per consentire un risparmio di tempo nel ciclo di lavoro. Il nuovo raschiatore STARMIX, con lama facilmente amovibile, assicura una perfetta aderenza alla vasca ed una facile igienizzazione alla fine del ciclo di lavoro.

Tools

The special whisk wire locking system makes the tool more resistant compared to the existing products and at the same time makes replacing it much easier. The scraper, available for any model starting from the 40 litres model, is an indispensable tool to obtain perfectly smooth and homogeneous dough and to save time during the work cycle. The new STARMIX scraper with easy to remove blade ensures perfect adherence to the bowl and is easy to sanitize at the end of the work cycle.

Les outils

Le spécial système de blocage des fils des fouets les rend plus résistants par rapport aux solutions traditionnelles sur le marché et au même temps rend leur éventuel remplacement plus facile. Le racleur, disponible pour tous les modèles dès celui de 40 litres, est à considérer indispensable afin d'obtenir une pâte parfaitement homogène et pour épargner du temps pendant le cycle de travail. Le nouveau racleur STARMIX avec racle facilement amovible garantit une adhérence optimale à la cuve et un nettoyage facile à la fin du cycle de travail.

Las herramientas

El sistema especial de bloqueo de los alambres de las batidoras las vuelve mucho más resistentes con respecto a las soluciones tradicionales existentes y, al mismo tiempo, facilita su posible sustitución. La rasqueta, que está disponible para todos los modelos a partir de los 40 litros, tiene que considerarse un instrumento imprescindible para obtener una homogeneidad perfecta de la masa y para permitir un ahorro de tiempo en el ciclo de trabajo. La nueva rasqueta STARMIX, con una cuchilla fácilmente removible, asegura una adherencia perfecta a la cuba y una higienización fácil a la terminación del ciclo de trabajo.

Рабочие инструменты

Специальная система крепления прутков венчика гарантирует его длительную эксплуатацию по сравнению с уже существующими системами и в то же время облегчает процесс их замены. Скребок, насадка, которая доступна для моделей от 40 литров, является необходимым инструментом, обеспечивающим идеальную однородность смеси и позволяющим сократить время рабочего процесса. Новый скребок STARMIX, со съёмным лезвием, гарантирует его плотное прилегание к деже и облегчает процесс его очистки в конце рабочего цикла.



Mescolatrici planetarie
Planetary mixers
Batteurs mélangeurs
Mezcladores planetarios
Планетарные миксеры

Le protezioni antinfortunistiche

Le nuove protezioni antinfortunistiche in plastica, fisse/girevoli o amovibili, hanno un grado elevatissimo di resistenza agli urti, proteggono dalla emissione di polveri nell'ambiente circostante, hanno superfici lisce di facile pulizia. L'apposito design impedisce lo "splashing out" del prodotto e un imbuto capiente favorisce l'aggiunta degli ingredienti. La versione amovibile può essere lavata in macchine lava oggetti automatiche che ne assicurano una perfetta igienizzazione.

Accident prevention guards

The design of the new plastic safety guards, both fixed/rotating and removable, guarantees high impact resistance, protection against dust emission in the surrounding area, features smooth and easy to clean surfaces and avoids product splashing out, and finally facilitates ingredient addition thanks to an ample funnel. The removable version can be washed on an automatic component washer thus ensuring perfect sanitization.

Les carters de sécurités

Les nouvelles protections de sécurité en plastique, fixes/tournantes ou amovibles, sont très résistants aux chocs, protègent des émissions de poussière dans l'environnement, ont des surfaces lisses permettant un nettoyage facile, évitent les éclaboussures de produit grâce au design particulier et permettent de rajouter des ingrédients à travers un grand entonnoir. La version amovible peut être lavée dans des machines lave-outils automatiques qui en garantissent une désinfection optimale.

Las protecciones para la prevención de accidentes

Los nuevos dispositivos de protección en plástico, fijos/giratorios o desmontables, tienen un nivel muy elevado de resistencia a los golpes, protegen contra la emisión de polvos en el ambiente circunstante, tienen superficies lisas de limpieza fácil, evitan el splashing out del producto, gracias a un diseño específico y favorecen la añadidura de los ingredientes, gracias a un embudo capaz. La versión removable permite ser lavada en máquinas lava-objetos automáticas, asegurando su higienización perfecta.

Система безопасности

Новые несъемные/поворотные или съемные предохранительные устройства из пластмассы, обладает высокой удароустойчивостью, защищает от пыли, образующейся в помещении, отличается гладкой поверхностью, что облегчает удаление загрязнений с её поверхности, защищает от разбрызгивания смеси благодаря уникальному дизайну и упрощает процесс добавления продуктов, благодаря наличию специальной воронки. Съемную модель крышки можно мыть в специальных моющих машинах, обеспечивая таким образом её идеальную гигиену.



10 > 600

La “famiglia” più grande al mondo

Con la nuova nata, PL600P, STARMIX rappresenta la “famiglia” più grande al mondo per le mescolatrici planetarie, con capacità vasca da 10 litri fino ad arrivare a 600 litri. L'enorme varietà di modelli è in grado di soddisfare tutte le esigenze, anche quelle della clientela più esigente.

The largest “family” in the world

The latest addition to the range of products, the PL600P means that STARMIX offers the largest range of planetary mixers in the world, with bowl capacity ranging from 10 to 600 litres. The huge variety of models and versions can meet the needs of even the most demanding customer.

La “famille” la plus grande au monde

Avec le dernier modèle développé, PL600P, STARMIX représente la « famille » la plus grande au monde de batteurs mélangeurs, avec une capacité des cuves qui varie de 10 litres à 600 litres. La très grande variété de modèles et de versions nous permet de satisfaire tous les besoins, même celles des clients les plus exigeants.

La “familia” más grande del mundo

Con la nueva nacida, PL600P, STARMIX representa la “familia” más grande del mundo para las mezcladoras planetarias, con una capacidad de la cuba de 10 litros, hasta llegar a 600 litros. La enorme variedad de modelos y de versiones puede responder a todas las demandas, incluyendo las de los clientes más exigentes.

Самая большая «семья» в мире

Выпуск последней модели PL600P позволил предприятию STARMIX создать самую большую в мире «семью» планетарных миксеров с дежой объёмом от 10-ти до 600-ста литров. Огромное разнообразие моделей и версий позволяет удовлетворить потребности всех пользователей, даже самых взыскательных.

» Touch screen IP54

Mescolatrici planetarie
Planetary mixers
Batteurs mélangeurs
Mezcladores planetarios
Планетарные миксеры

Il pannello touch commands IP54

La nuova gamma di mescolatrici planetarie STARMIX serie H, abbina alla riconosciuta solidità meccanica, l'innovativa tecnologia TOUCH COMMANDS.

I touch commands custom made hanno premiato STARMIX che per prima li ha applicati sulle mescolatrici planetarie.

I comandi che si attivano al solo tocco sul pannello, senza esercitare alcuna pressione, le icone user-friendly che facilitano l'operatore, le guarnizioni che impediscono alla polvere e all'acqua di entrare in contatto con i componenti elettrici, sono caratteristiche studiate nei minimi dettagli che ci hanno permesso di realizzare un prodotto all'avanguardia e di testata affidabilità.

Touch commands panel IP54

The new series H STARMIX planetary mixers range combines to the already established mechanical sturdiness the innovative TOUCH COMMANDS technology.

STARMIX was the first to implement the custom made touch commands on planetary mixers and this gamble has paid off.

The controls are activated by touching the panel: no pressure needed. The user-friendly icons help the operator, the gaskets prevent dust and water from coming into contact with the electric components: all these details have been studied in depth and have enabled us to create a state-of-the-art product of proven reliability.



STARMIX
TOUCH COMMANDS

L'écran tactile IP54

La nouvelle gamme de batteurs mélangeurs STARMIX série H combine la fameuse mécanique robuste à l'innovation technologique TOUCH COMMANDS.

Les commandes tactiles personnalisées ont été appliquées aux batteurs mélangeurs pour la première fois par STARMIX.

Les commandes s'activent au contact du doigt avec l'écran sans aucune pression, les icônes conviviales qui rend le travail de l'opérateur plus facile, les joints empêchant à la poussière et à l'eau d'entrer en contact avec les composants électriques sont des détails que nous avons conçus attentivement et qui nous ont permis de développer un produit à l'avant-garde et avec une tête fiable.

Panel de mandos Touch IP54

La nueva gama de mezcladoras planetarias STARMIX serie H combina a la solidez mecánica reconocida, la tecnología innovadora TOUCH COMMANDS.

Los controles táctiles personalizados han premiado STARMIX, que ha sido la primera en aplicarlos en las mezcladoras planetarias.

Los controles que se activan solamente tocando el cuadro, sin que se tenga que ejercer ninguna presión, los iconos friendly use que facilitan el operador, las juntas que impiden al polvo y al agua entrar en contacto con los componentes eléctricos, son detalles que hemos estudiado pormenorizadamente y que nos han llevado a desarrollar un producto de vanguardia y de probada fiabilidad.

Панель управления с сенсорным экраном IP54

Новые модели планетарных миксеров STARMIX серии H отличаются прочной механической конструкцией и ПАНЕЛЯМИ УПРАВЛЕНИЯ С СЕНСОРНЫМ ЭКРАНОМ, созданными по последним технологиям.

Панели управления с сенсорным экраном, выполненные на заказ, были впервые выпущены компанией STARMIX и являются отличительной характеристикой её продукции.

Управление, которое запускается лёгким касанием экрана без малейшего давления, упрощающие работу оператора, и уплотнители, защищающие от попадания пыли и воды в электрические механизмы, являются деталями, которые были тщательно изучены и разработаны и которые позволили нам создать надёжный продукт, соответствующий передовым технологиям.

» PL20BNH



PL20BNVH

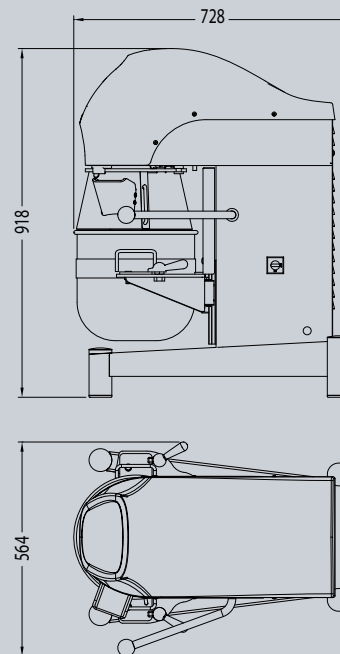

- Capacità vasca 20 litri
- Variatore elettronico di velocità con inverter
- Pannello touch commands IP54
- Versione da banco e da pavimento
- Sollevamento vasca manuale
- Protezione antinfortunistica fissa/girevole in plastica "F"
- Struttura in acciaio verniciato o in acciaio inox su richiesta

- Bowl capacity 20 liters
- Electronic variable speed by inverter
- Touch commands panel IP54
- Bench and floor version
- Manual bowl lift
- Fixed rotating plastic safety guard "F"
- Structure in painted steel or in stainless steel on request

- Capacité cuve 20 litres
- Variateur électronique de vitesse par inverter
- Panneau de commandes touch IP54
- Version à poser sur table ou à poser au sol
- Levage de la cuve manuel
- Protection de sécurité fixe tournant en plastique "F"
- Structure en acier verni ou acier inox sur demande

- Capacidad cuba 20 litros
- Variador electrónico de velocidad con inverter
- Panel de comando touch IP54
- Versión de sobre mesa y suelo
- Elevación manual del perol
- Protección de seguridad fija giratoria de plástico "F"
- Estructura de acero pintado o acero inox bajo demanda

- Объем дежи 20 л
- Электронный вариатор скорости
- Панель управления с сенсорным экраном IP54
- Настольные и напольные модели миксера
- Миксер с подъемом дежи вручную
- Корпус из окрашенной или нержавеющей стали (по запросу)

Accessori standard - Standard accessories



Vasca
Bowl



Protezione fissa/girevole in plastica "F"
Fixed rotating plastic safety guard "F"



Frusta fili fini
Fine wire whisk

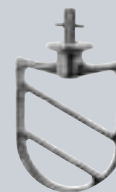

Spatola in alluminio
Aluminium beater



Gancio in alluminio
Aluminium hook

Codice macchina Machine code	Capacità vasca Bowl capacity	Peso macchina Machine weight	Potenza Power	Velocità Speed	Voltaggio standard Standard voltage	Riduzioni Reduction
	l	kg	kW	rpm	V / PH / Hz	l
PL20BNVHF	20	90	1,1	min. 47 (120) max. 164 (418)	230 / 1 / 50 - 60	10



» PL20CNH



PL20CNVH

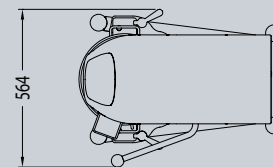
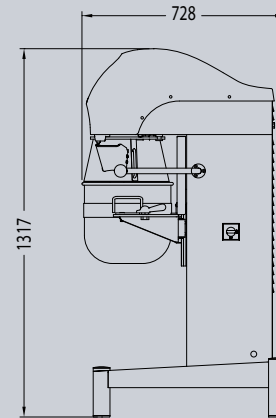

- Capacità vasca 20 litri
- Variatore elettronico di velocità con inverter
- Pannello touch commands IP54
- Versione da banco e da pavimento
- Sollevamento vasca manuale
- Protezione antinfortunistica fissa/girevole in plastica "F"
- Struttura in acciaio verniciato o in acciaio inox su richiesta

- Bowl capacity 20 liters
- Electronic variable speed by inverter
- Touch commands panel IP54
- Bench and floor version
- Manual bowl lift
- Fixed rotating plastic safety guard "F"
- Structure in painted steel or in stainless steel on request

- Capacité cuve 20 litres
- Variateur électronique de vitesse par inverter
- Panneau de commandes touch IP54
- Version à poser sur table ou à poser au sol
- Levage de la cuve manuel
- Protection de sécurité fixe tournant en plastique "F"
- Structure en acier verni ou acier inox sur demande

- Capacidad cuba 20 litros
- Variador electrónico de velocidad con inverter
- Panel de comando touch IP54
- Versión de sobre mesa y suelo
- Elevación manual del perol
- Protección de seguridad fija giratoria de plástico "F"
- Estructura de acero pintado o acero inox bajo demanda

- Объем дежи 20 л
- Электронный вариатор скорости
- Панель управления с сенсорным экраном IP54
- Настольные и напольные модели миксера
- Миксер с подъемом дежи вручную
- Фиксированная пластиковая защита "F"
- Корпус из окрашенной или нержавеющей стали (по запросу)

Accessori standard - Standard accessories



Vasca
Bowl



Protezione fissa/girevole in plastica "F"
Fixed rotating plastic safety guard "F"



Frusta fili fini
Fine wire whisk



Spatola in alluminio
Aluminium beater



Gancio in alluminio
Aluminium hook

Codice macchina Machine code	Capacità vasca Bowl capacity	Peso macchina Machine weight	Potenza Power	Velocità Speed	Voltaggio standard Standard voltage	Riduzioni Reduction
	l	kg	kW	rpm	V / PH / Hz	l
PL20CNVHF	20	100	1,1	min. 47 (120) max. 164 (418)	230 / 1 / 50 - 60	10



» PL30NH



PL30NVH

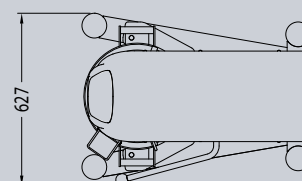
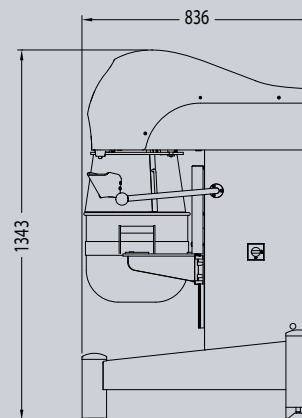

- Capacità vasca 30 litri
- Variatore elettronico di velocità con inverter
- Pannello touch commands IP54
- Sollevamento vasca manuale
- Protezione antinfortunistica fissa/girevole in plastica "F"
- Struttura in acciaio verniciato o in acciaio inox su richiesta

- Bowl capacity 30 liters
- Electronic variable speed by inverter
- Touch commands panel IP54
- Manual bowl lift
- Fixed rotating plastic safety guard "F"
- Structure in painted steel or in stainless steel on request

- Capacité cuve 30 litres
- Variateur électronique de vitesse par inverter
- Panneau de commandes touch IP54
- Levage de la cuve manuel
- Protection de sécurité fixe tournant en plastique "F"
- Structure en acier verni ou acier inox sur demande

- Capacidad cuba 30 litros
- Variador electrónico de velocidad con inverter
- Panel de comando touch IP54
- Elevación manual del perol
- Protección de seguridad fija giratoria de plástico "F"
- Estructura de acero pintado o acero inox bajo demanda

- Объем дежи 30 л
- Электронный вариатор скорости
- Панель управления с сенсорным экраном IP54
- Миксер с подъемом дежи вручную
- Фиксированная пластиковая защита "F"
- Корпус из окрашенной или нержавеющей стали (по запросу)

Accessori standard - Standard accessories



Vasca
Bowl



Protezione fissa/girevole in plastica "F"
Fixed rotating plastic safety guard "F"



Frusta fili fini
Fine wire whisk

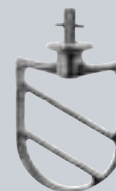

Spatola in alluminio
Aluminium beater



Gancio in alluminio
Aluminium hook

Codice macchina Machine code	Capacità vasca Bowl capacity	Peso macchina Machine weight	Potenza Power	Velocità Speed	Voltaggio standard Standard voltage	Riduzioni Reduction
	l	kg	kW	rpm	V / PH / Hz	l
PL30NVHF	30	180	1,5	min. 38 (83) max. 150 (333)	230 / 1 / 50 - 60	/



» PL40NH



PL40NVH / PL40NVAH

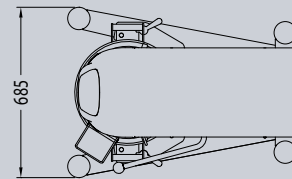
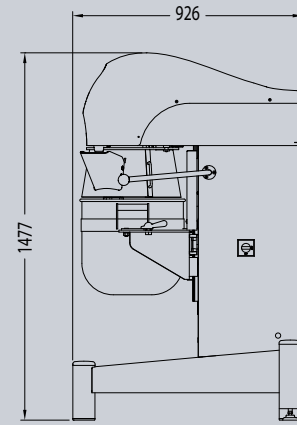

- Capacità vasca 40 litri
- Variatore elettronico di velocità con inverter
- Pannello touch commands IP54
- Sollevamento vasca manuale o automatico su richiesta
- Protezione antinfortunistica fissa/girevole in plastica "F"
- Struttura in acciaio verniciato o in acciaio inox su richiesta

- Bowl capacity 40 liters
- Electronic variable speed by inverter
- Touch commands panel IP54
- Manual bowl lift or automatic on request
- Fixed rotating plastic safety guard "F"
- Structure in painted steel or in stainless steel on request

- Capacité cuve 40 litres
- Variateur électronique de vitesse par inverter
- Panneau de commandes touch IP54
- Levage de la cuve manuel ou automatique sur demande
- Protection de sécurité fixe tournant en plastique "F"
- Structure en acier verni ou acier inox sur demande

- Capacidad cuba 40 litros
- Variador electrónico de velocidad con inverter
- Panel de comando touch IP54
- Elevación manual del perol o automático bajo demanda
- Protección de seguridad fija giratoria de plástico "F"
- Estructura de acero pintado o acero inox bajo demanda

- Объем дежи 40 л
- Электронный вариатор скорости
- Панель управления с сенсорным экраном IP54
- Миксер с подъемом дежи вручную или автоматическим подъемом (по запросу)
- Фиксированная пластиковая защита "F"
- Корпус из окрашенной или нержавеющей стали (по запросу)

Accessori standard - Standard accessories



Vasca
Bowl



Protezione fissa/girevole in plastica "F"
Fixed rotating plastic safety guard "F"



Frusta fili fini
Fine wire whisk



Spatola in alluminio
Aluminium beater



Gancio in alluminio
Aluminium hook

Codice macchina Machine code	Capacità vasca Bowl capacity l	Peso macchina Machine weight kg	Potenza Power kW	Velocità Speed rpm	Voltaggio standard Standard voltage V / PH / Hz	Riduzioni Reduction l
PL40NVHF	40	210	2,2	min. 36 (80) max. 160 (353)	400 / 3 / 50 230 / 1 / 50 - 60	20
PL40NVAHF	40	210	2,2 + 0,5	min. 36 (80) max. 160 (353)	400 / 3 / 50	20



» PL60NH



PL60NVH / PL60NVAH

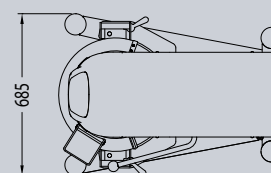
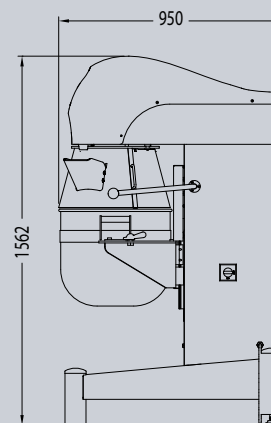

- Capacità vasca 60 litri
- Variatore elettronico di velocità con inverter
- Pannello touch commands IP54
- Sollevamento vasca manuale o automatico su richiesta
- Protezione antinfortunistica fissa/girevole in plastica "F"
- Struttura in acciaio verniciato o in acciaio inox su richiesta

- Bowl capacity 60 liters
- Electronic variable speed by inverter
- Touch commands panel IP54
- Manual bowl lift or automatic on request
- Fixed rotating plastic safety guard "F"
- Structure in painted steel or in stainless steel on request

- Capacité cuve 60 litres
- Variateur électronique de vitesse par inverter
- Panneau de commandes touch IP54
- Levage de la cuve manuel ou automatique sur demande
- Protection de sécurité fixe tournant en plastique "F"
- Structure en acier verni ou acier inox sur demande

- Capacidad cuba 60 litros
- Variador electrónico de velocidad con inverter
- Panel de comando touch IP54
- Elevación manual del perol o automático bajo demanda
- Protección de seguridad fija giratoria de plástico "F"
- Estructura de acero pintado o acero inox bajo demanda

- Объем дежи 60 л
- Электронный вариатор скорости
- Панель управления с сенсорным экраном IP54
- Миксер с подъемом дежи вручную или автоматическим подъемом дежи (по запросу)
- Фиксированная пластиковая защита "F"
- Корпус из окрашенной или нержавеющей стали (по запросу)

Accessori standard - Standard accessories



Vasca
Bowl



Protezione fissa/girevole in plastica "F"
Fixed rotating plastic safety guard "F"



Frusta fili fini
Fine wire whisk

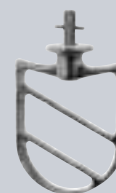

Spatola in alluminio
Aluminium beater



Gancio in alluminio
Aluminium hook

Codice macchina Machine code	Capacità vasca Bowl capacity l	Peso macchina Machine weight kg	Potenza Power kW	Velocità Speed rpm	Voltaggio standard Standard voltage V / PH / Hz	Riduzioni Reduction l
PL60NVHF	60	230	3	min. 36 (80) max. 160 (353)	400 / 3 / 50 230 / 1 / 50 - 60	20/40
PL60NVAHF	60	230	3 + 0,5	min. 36 (80) max. 160 (353)	400 / 3 / 50	20/40







» PL80NH



PL80NVAH

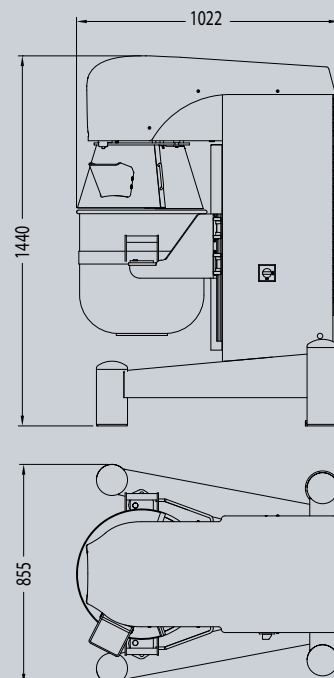

- Capacità vasca 80 litri
- Variatore elettronico di velocità con inverter
- Pannello touch commands IP54
- Sollevamento vasca automatico
- Protezione antinfortunistica fissa/girevole in plastica "F"
- Struttura in acciaio verniciato o in acciaio inox su richiesta

- Bowl capacity 80 liters
- Electronic variable speed by inverter
- Touch commands panel IP54
- Automatic bowl lift
- Fixed rotating plastic safety guard "F"
- Structure in painted steel or in stainless steel on request

- Capacité cuve 80 litres
- Variateur électronique de vitesse par inverter
- Panneau de commandes touch IP54
- Levage de la cuve automatique
- Protection de sécurité fixe tournant en plastique "F"
- Structure en acier verni ou acier inox sur demande

- Capacidad cuba 80 litros
- Variador electrónico de velocidad con inverter
- Panel de comando touch IP54
- Elevación automático del perol
- Protección de seguridad fija giratoria de plástico "F"
- Estructura de acero pintado o acero inox bajo demanda

- Объем дежи 80 л
- Электронный вариатор скорости
- Панель управления с сенсорным экраном IP54
- Миксер с автоматической системой поднятия дежи
- Фиксированная пластиковая защита "F"
- Корпус из окрашенной или нержавеющей стали (по запросу)

Accessori standard - Standard accessories



Vasca
Bowl



Protezione fissa/girevole in plastica "F"
Fixed rotating plastic safety guard "F"



Frusta fili fini
Fine wire whisk



Spatola in alluminio
Aluminium beater



Spirale in alluminio
Aluminium spiral

Codice macchina Machine code	Capacità vasca Bowl capacity l	Peso macchina Machine weight kg	Potenza Power kW	Velocità Speed rpm	Voltaggio standard Standard voltage V / PH / Hz	Riduzioni Reduction l
PL80NVAHF	80	360	4,0 + 0,75	min. 33 (73) max. 150 (333)	400 / 3 / 50	40 / 60



» PL80SNH



PL80SNVAH

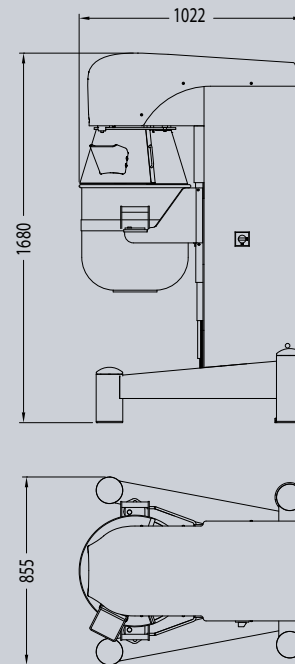

- Capacità vasca 80 litri
- Variatore elettronico di velocità con inverter
- Pannello touch commands IP54
- Sollevamento vasca automatico
- Estrazione vasca senza rimozione utensili
- Protezione antinfortunistica fissa/girevole in plastica "F"
- Struttura in acciaio verniciato o in acciaio inox su richiesta

- Bowl capacity 80 liters
- Electronic variable speed by inverter
- Touch commands panel IP54
- Automatic bowl lift
- Removal of the bowl without removing mixing tools
- Fixed rotating plastic safety guard "F"
- Structure in painted steel or in stainless steel on request

- Capacité cuve 80 litres
- Variateur électronique de vitesse par inverter
- Panneau de commandes touch IP54
- Levage de la cuve automatique
- Déplacement de la cuve sans déplacer l'outil
- Protection de sécurité fixe tournant en plastique "F"
- Structure en acier verni ou acier inox sur demande

- Capacidad cuba 80 litros
- Variador electrónico de velocidad con inverter
- Panel de comando touch IP54
- Elevación automático del perol
- Estracción del perol sin tener que extraer el utensilio en uso
- Protección de seguridad fija giratoria de plástico "F"
- Estructura de acero pintado o acero inox bajo demanda

- Объем дежи 80 л
- Электронный вариатор скорости
- Панель управления с сенсорным экраном IP54
- Миксер с автоматической системой поднятия дежи
- Извлечение дежи без снятия насадок
- Фиксированная пластиковая защита "F"
- Корпус из окрашенной или нержавеющей стали (по запросу)

Accessori standard - Standard accessories



Vasca
Bowl



Protezione fissa/girevole in plastica "F"
Fixed rotating plastic safety guard "F"



Frusta fili fini
Fine wire whisk



Spatola in alluminio
Aluminium beater



Spirale in alluminio
Aluminium spiral

Codice macchina Machine code	Capacità vasca Bowl capacity	Peso macchina Machine weight	Potenza Power	Velocità Speed	Voltaggio standard Standard voltage	Riduzioni Reduction
	l	kg	kW	rpm	V / PH / Hz	l
PL80SNVAHF	80	380	4,0 + 0,75	min. 33 (73) max. 150 (333)	400 / 3 / 50	40 / 60



» PL100NH



PL100NHVAH

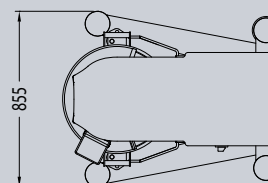
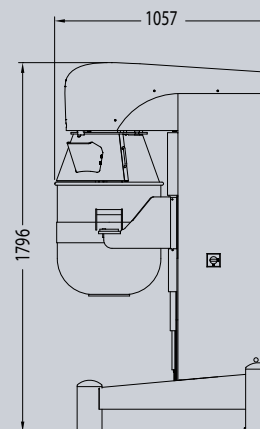

- Capacità vasca 100 litri
- Variatore elettronico di velocità con inverter
- Pannello touch commands IP54
- Sollevamento vasca automatico
- Estrazione vasca senza rimozione utensili
- Protezione antinfortunistica fissa/girevole in plastica "F"
- Struttura in acciaio verniciato o in acciaio inox su richiesta

- Bowl capacity 100 liters
- Electronic variable speed by inverter
- Touch commands panel IP54
- Automatic bowl lift
- Removal of the bowl without removing mixing tools
- Fixed rotating plastic safety guard "F"
- Structure in painted steel or in stainless steel on request

- Capacité cuve 100 litres
- Variateur électronique de vitesse par inverter
- Panneau de commandes touch IP54
- Levage de la cuve automatique
- Déplacement de la cuve sans déplacer l'outil
- Protection de sécurité fixe tournant en plastique "F"
- Structure en acier verni ou acier inox sur demande

- Capacidad cuba 100 litros
- Variador electrónico de velocidad con inverter
- Panel de comando touch IP54
- Elevación automático del perol
- Estracción del perol sin tener que extraer el utensilio en uso
- Protección de seguridad fija giratoria de plástico "F"
- Estructura de acero pintado o acero inox bajo demanda

- Объем дежи 100 л
- Электронный вариатор скорости
- Панель управления с сенсорным экраном IP54
- Миксер с автоматической системой поднятия дежи
- Извлечение дежи без снятия насадок
- Фиксированная пластиковая защита "F"
- Корпус из окрашенной или нержавеющей стали (по запросу)

Accessori standard - Standard accessories



Vasca
Bowl



Protezione fissa/girevole in plastica "F"
Fixed rotating plastic safety guard "F"



Frusta fili fini
Fine wire whisk



Spatola in alluminio
Aluminium beater



Spirale in alluminio
Aluminium spiral

Codice macchina Machine code	Capacità vasca Bowl capacity	Peso macchina Machine weight	Potenza Power	Velocità Speed	Voltaggio standard Standard voltage	Riduzioni Reduction
	l	kg	kW	rpm	V / PH / Hz	l
PL100NVAHF	100	390	4,0 + 0,75	min. 33 (73) max. 150 (333)	400 / 3 / 50	40 / 60



» PL120NP



PL120NVAP

- Capacità vasca 120 litri
- Variatore elettronico di velocità con inverter
- PLC programmabile con touch screen
- Sollevamento vasca automatico
- Estrazione vasca senza rimozione utensili
- Protezione antinfortunistica fissa/girevole in plastica "F"
- Struttura in acciaio verniciato o in acciaio inox su richiesta

- Bowl capacity 120 liters
- Electronic variable speed by inverter
- Programmable PLC with touch screen
- Automatic bowl lift
- Removal of the bowl without removing the mixing tools
- Fixed rotating plastic safety guard "F"
- Structure in painted steel or in stainless steel on request

- Capacité cuve 120 litres
- Variateur électronique de vitesse par inverter
- API de programmation avec écran tactile
- Levage de la cuve automatique
- Déplacement de la cuve sans déplacer l'outil
- Protection de sécurité fixe tournant en plastique "F"
- Structure en acier verni ou acier inox sur demande

- Capacidad cuba 120 litros
- Variador electrónico de velocidad con inverter
- PLC para programar recetas con pantalla táctil
- Elevación automático del perol
- Extracción del perol sin tener que extraer el utensilio en uso
- Protección de seguridad fija giratoria de plástico "F"
- Estructura de acero pintado o acero inox bajo demanda

- Объем дежи 120 л
- Электронный вариатор скорости
- Программируемая панель управления посредством сенсорного монитора
- Миксер с автоматической системой поднятия дежи
- Извлечение дежи без снятия насадок
- Фиксированная пластиковая защита "F"
- Корпус из окрашенной или нержавеющей стали (по запросу)

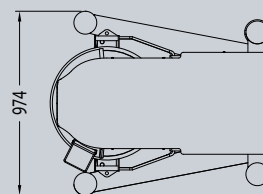
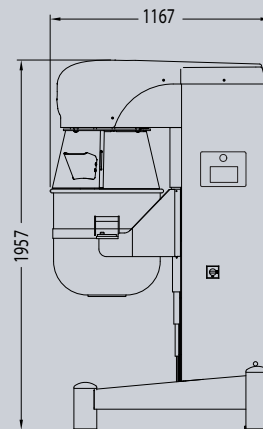

Accessori standard - Standard accessories



Vasca
Bowl



Protezione fissa/girevole in plastica "F"
Fixed rotating plastic safety guard "F"



Frusta fili fini
Fine wire whisk



Spatola in alluminio
Aluminium beater



Spirale in alluminio
Aluminium spiral

Codice macchina Machine code	Capacità vasca Bowl capacity	Peso macchina Machine weight	Potenza Power	Velocità Speed	Voltaggio standard Standard voltage	Riduzioni Reduction
	l	kg	kW	rpm	V / PH / Hz	l
PL120NVAPF	120	575	5,5 + 0,75	min. 28 (62) max. 120 (265)	400 / 3 / 50	/



» PL140NP



PL140NPVAP

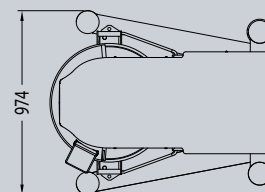
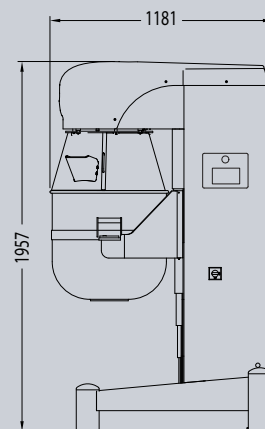

- Capacità vasca 140 litri
- Variatore elettronico di velocità con inverter
- PLC programmabile con touch screen
- Sollevamento vasca automatico
- Estrazione vasca senza rimozione utensili
- Protezione antinfortunistica fissa/girevole in plastica "F"
- Struttura in acciaio verniciato o in acciaio inox su richiesta

- Bowl capacity 140 liters
- Electronic variable speed by inverter
- Programmable PLC with touch screen
- Automatic bowl lift
- Removal of the bowl without removing the mixing tools
- Fixed rotating plastic safety guard "F"
- Structure in painted steel or in stainless steel on request

- Capacité cuve 140 litres
- Variateur électronique de vitesse par inverter
- API de programmation avec écran tactile
- Levage de la cuve automatique
- Déplacement de la cuve sans déplacer l'outil
- Protection de sécurité fixe tournant en plastique "F"
- Structure en acier verni ou acier inox sur demande

- Capacidad cuba 140 litros
- Variador electrónico de velocidad con inverter
- PLC para programar recetas con pantalla táctil
- Elevación automático del perol
- Extracción del perol sin tener que extraer el utensilio en uso
- Protección de seguridad fija giratoria de plástico "F"
- Estructura de acero pintado o acero inox bajo demanda

- Объем дежи 140 л
- Электронный вариатор скорости
- Программируемая панель управления посредством сенсорного монитора
- Миксер с автоматической системой поднятия дежи
- Извлечение дежи без снятия насадок
- Фиксированная пластиковая защита "F"
- Корпус из окрашенной или нержавеющей стали (по запросу)

Accessori standard - Standard accessories



Vasca
Bowl



Protezione fissa/girevole in plastica "F"
Fixed rotating plastic safety guard "F"



Frusta fili fini
Fine wire whisk



Spatola in alluminio
Aluminium beater



Spirale in alluminio
Aluminium spiral

Codice macchina Machine code	Capacità vasca Bowl capacity	Peso macchina Machine weight	Potenza Power	Velocità Speed	Voltaggio standard Standard voltage	Riduzioni Reduction
	l	kg	kW	rpm	V / PH / Hz	l
PL140NPVAPF	140	595	5,5 + 0,75	min. 28 (62) max. 120 (265)	400 / 3 / 50	/



» Elettromeccanico

Electromechanical
Électromécanique
Electromecánico
Электромеханическая





» PL20BN

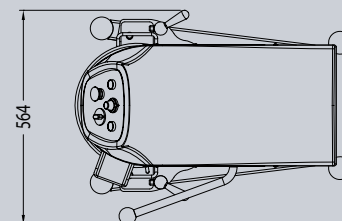
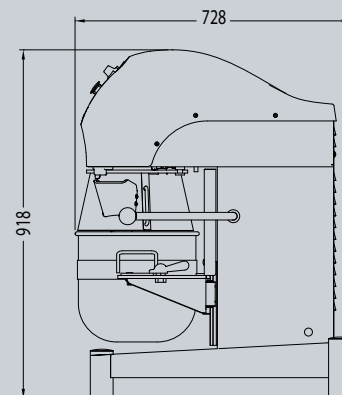

PL20BN2



PL20BNV

- Capacità vasca 20 litri
- Versioni a 2 velocità o con variatore elettronico di velocità con inverter
- Pannello comandi elettromeccanico
- Versione da banco e da pavimento
- Sollevamento vasca manuale
- Protezione antinfortunistica fissa/girevole in plastica "F"
- Struttura in acciaio verniciato o in acciaio inox su richiesta

- Bowl capacity 20 liters
- Models by 2 speed or by electronic variable speed by inverter
- Electromechanical control panel
- Bench and floor version
- Manual bowl lift
- Fixed rotating plastic safety guard "F"
- Structure in painted steel or in stainless steel on request

- Capacité cuve 20 litres
- Modèles par 2 vitesses ou par variateur électronique de vitesse par inverter
- Panneau de commandes électromécanique
- Version à poser sur table ou à poser au sol
- Levage de la cuve manuel
- Protection de sécurité fixe tournant en plastique "F"
- Structure en acier verni ou acier inox sur demande

- Capacidad cuba 20 litros
- Modelos 2 velocidades o con variador electrónico de velocidad con inverter
- Versión de sobre mesa y suelo
- Panel de comando electromecánico
- Elevación manual del perol
- Protección de seguridad fija giratoria de plástico "F"
- Estructura de acero pintado o acero inox bajo demanda

- Объем дежи 20 л
- Модель с двумя скоростями или с электронным вариатором скорости посредством инвертора
- Настольные и напольные модели миксера
- Электромеханическая панель управления
- Миксер с подъемом дежи вручную
- Фиксированная пластиковая защита "F"
- Корпус из окрашенной или нержавеющей стали (по запросу)

Accessori standard - Standard accessories



Vasca
Bowl



Protezione fissa/girevole in plastica "F"
Fixed rotating plastic safety guard "F"



Frusta fili fini
Fine wire whisk



Spatola in alluminio
Aluminium beater



Gancio in alluminio
Aluminium hook

Codice macchina Machine code	Capacità vasca Bowl capacity l	Peso macchina Machine weight kg	Potenza Power kW	Velocità Speed rpm	Voltaggio standard Standard voltage V / PH / Hz	Riduzioni Reduction l
PL20BN2F	20	90	0,42 / 0,8	1° 61 (155) 2° 122 (311)	400 / 3 / 50	10
PL20BNVF	20	90	1,1	min. 47 (120) max. 164 (418)	230 / 1 / 50 - 60	10



» PL20CN

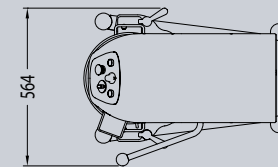
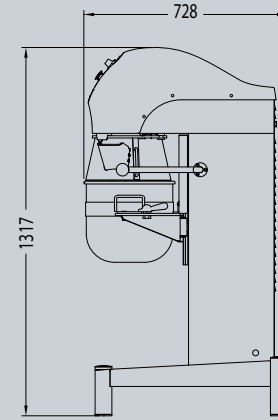

PL20CN2



PL20CNV

- Capacità vasca 20 litri
- Versioni a 2 velocità o con variatore elettronico di velocità con inverter
- Pannello comandi elettromeccanico
- Versione da banco e da pavimento
- Protezione antinfortunistica fissa/girevole in plastica "F"
- Struttura in acciaio verniciato o in acciaio inox su richiesta

- Bowl capacity 20 liters
- Models by 2 speed or by electronic variable speed by inverter
- Electromechanical control panel
- Bench and floor version
- Manual bowl lift
- Fixed rotating plastic safety guard "F"
- Structure in painted steel or in stainless steel on request

- Capacité cuve 20 litres
- Modèles par 2 vitesses ou par variateur électronique de vitesse par inverter
- Panneau de commandes électromécanique
- Version à poser sur table ou à poser au sol
- Levage de la cuve manuel
- Protection de sécurité fixe tournant en plastique "F"
- Structure en acier verni ou acier inox sur demande

- Capacidad cuba 20 litros
- Modelos 2 velocidades o con variador electrónico de velocidad con inverter
- Versión de sobre mesa y suelo
- Panel de comando electromecánico
- Elevación manual del perol
- Protección de seguridad fija giratoria de plástico "F"
- Estructura de acero pintado o acero inox bajo demanda

- Объем дежи 20 л
- Модель с двумя скоростями или с электронным вариатором скорости посредством инвертора
- Настольные и напольные модели миксера
- Электромеханическая панель управления
- Миксер с подъемом дежи вручную
- Фиксированная пластиковая защита "F"
- Корпус из окрашенной или нержавеющей стали (по запросу)

Accessori standard - Standard accessories



Vasca
Bowl



Protezione fissa/girevole in plastica "F"
Fixed rotating plastic safety guard "F"



Frusta fili fini
Fine wire whisk



Spatola in alluminio
Aluminium beater



Gancio in alluminio
Aluminium hook

Codice macchina Machine code	Capacità vasca Bowl capacity l	Peso macchina Machine weight kg	Potenza Power kW	Velocità Speed rpm	Voltaggio standard Standard voltage V / PH / Hz	Riduzioni Reduction l
PL20CN2F	20	100	0,42 / 0,8	1° 61 (155) 2° 122 (311)	400 / 3 / 50	10
PL20CNVF	20	100	1,1	min. 47 (120) max. 164 (418)	230 / 1 / 50 - 60	10



» PL30N



PL30N3



PL30NV

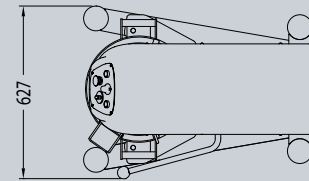
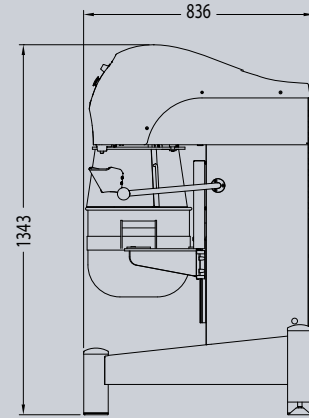

- Capacità vasca 30 litri
- Versioni a 3 velocità o con variatore elettronico di velocità con inverter
- Pannello comandi elettromeccanico
- Sollevamento vasca manuale
- Protezione antinfortunistica fissa/girevole in plastica "F"
- Struttura in acciaio verniciato o in acciaio inox su richiesta

- Bowl capacity 30 liters
- Models by 3 speed or by electronic variable speed by inverter
- Electromechanical control panel
- Manual bowl lift
- Fixed rotating plastic safety guard "F"
- Structure in painted steel or in stainless steel on request

- Capacité cuve 30 litres
- Modèles par 3 vitesses ou par variateur électronique de vitesse par inverter
- Panneau de commandes électromécanique
- Levage de la cuve manuel
- Protection de sécurité fixe tournant en plastique "F"
- Structure en acier verni ou acier inox sur demande

- Capacidad cuba 30 litros
- Modelos 3 velocidades o con variador electrónico de velocidad con inverter
- Panel de comando electromecánico
- Elevación manual del perol
- Protección de seguridad fija giratoria de plástico "F"
- Estructura de acero pintado o acero inox bajo demanda

- Объем дежи 30 л
- Модель с тремя скоростями или с электронным вариатором скорости посредством инвертора
- Электромеханическая панель управления
- Миксер с подъемом дежи вручную
- Фиксированная пластиковая защита "F"
- Корпус из окрашенной или нержавеющей стали (по запросу)

Accessori standard - Standard accessories



Vasca
Bowl



Protezione fissa/girevole in plastica "F"
Fixed rotating plastic safety guard "F"



Frusta fili fini
Fine wire whisk



Spatola in alluminio
Aluminium beater



Gancio in alluminio
Aluminium hook

Codice macchina Machine code	Capacità vasca Bowl capacity l	Peso macchina Machine weight kg	Potenza Power kW	Velocità Speed rpm	Voltaggio standard Standard voltage V / PH / Hz	Riduzioni Reduction l
PL30N3F	30	180	0,45 / 0,8 / 1,2	1° 41 (90) 2° 82 (198) 3° 164 (362)	400 / 3 / 50	/
PL30NVF	30	180	1,5	min. 38 (83) max. 150 (333)	230 / 1 / 50 - 60	/



» PL40N



PL40N3



PL40N3A



PL40NV



PL40NVA

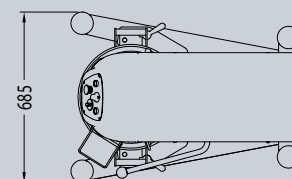
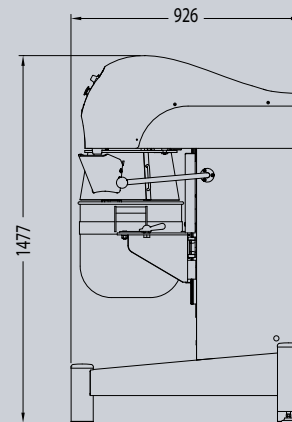

- Capacità vasca 40 litri
- Versioni a 3 velocità o con variatore elettronico di velocità con inverter
- Pannello comandi elettromeccanico
- Sollevamento vasca manuale o automatico su richiesta
- Protezione antinfortunistica fissa/girevole in plastica "F"
- Struttura in acciaio verniciato o in acciaio inox su richiesta

- Bowl capacity 40 liters
- Models by 3 speed or by electronic variable speed by inverter
- Electromechanical control panel
- Manual bowl lift or automatic on request
- Fixed rotating plastic safety guard "F"
- Structure in painted steel or in stainless steel on request

- Capacité cuve 40 litres
- Modèles par 3 vitesses ou par variateur électronique de vitesse par inverter
- Panneau de commandes électromécanique
- Levage de la cuve manuel ou automatique sur demande
- Protection de sécurité fixe tournant en plastique "F"
- Structure en acier verni ou acier inox sur demande

- Capacidad cuba 40 litros
- Modelos 3 velocidades o con variador electrónico de velocidad con inverter
- Panel de comando electromecánico
- Elevación manual del perol o automático bajo demanda
- Protección de seguridad fija giratoria de plástico "F"
- Estructura de acero pintado o acero inox bajo demanda

- Объем дежи 40 л
- Модель с тремя скоростями или с электронным вариатором скорости посредством инвертера
- Панель управления с сенсорным экраном
- Миксер с подъемом дежи вручную или автоматическим подтягиванием дежи (по запросу)
- Фиксированная пластиковая защита "F"
- Корпус из окрашенной или нержавеющей стали (по запросу)

Accessori standard - Standard accessories



Vasca
Bowl



Protezione fissa/girevole in plastica "F"
Fixed rotating plastic safety guard "F"



Frusta fili fini
Fine wire whisk



Spatola in alluminio
Aluminium beater



Gancio in alluminio
Aluminium hook

Codice macchina Machine code	Capacità vasca Bowl capacity l	Peso macchina Machine weight kg	Potenza Power kW	Velocità Speed rpm	Voltaggio standard Standard voltage V / PH / Hz	Riduzioni Reduction l
PL40N3F	40	210	0,59 / 1,1 / 1,5	1° 36 (80) 2° 73 (162) 3° 145 (320)	400 / 3 / 50	20
PL40N3AF	40	210	0,59 / 1,1 / 1,5 + 0,5	1° 36 (80) 2° 73 (162) 3° 145 (320)	400 / 3 / 50	20
PL40NVF	40	210	2,2	min. 36 (80) max. 160 (353)	400 / 3 / 50 230 / 1 / 50 - 60	20
PL40NVAF	40	210	2,2 + 0,5	min. 36 (80) max. 160 (353)	400 / 3 / 50	20



» PL60N



PL60N3



PL60N3A



PL60NV



PL60NVA

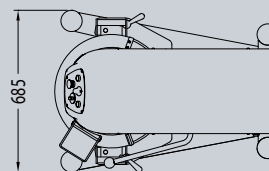
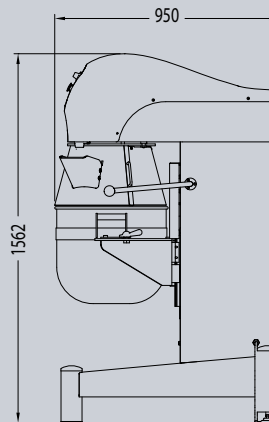

- Capacità vasca 60 litri
- Versioni a 3 velocità o con variatore elettronico di velocità con inverter
- Pannello comandi elettromeccanico
- Sollevamento vasca manuale o automatico su richiesta
- Protezione antinfortunistica fissa/girevole in plastica "F"
- Struttura in acciaio verniciato o in acciaio inox su richiesta

- Bowl capacity 60 liters
- Models by 3 speed or by electronic variable speed by inverter
- Electromechanical control panel
- Manual bowl lift or automatic on request
- Fixed rotating plastic safety guard "F"
- Structure in painted steel or in stainless steel on request

- Capacité cuve 60 litres
- Modèles par 3 vitesses ou par variateur électronique de vitesse par inverter
- Panneau de commandes électromécanique
- Levage de la cuve manuel ou automatique sur demande
- Protection de sécurité fixe tournant en plastique "F"
- Structure en acier verni ou acier inox sur demande

- Capacidad cuba 60 litros
- Modelos 3 velocidades o con variador electrónico de velocidad con inverter
- Panel de comando electromecánico
- Elevación manual del perol o automático bajo demanda
- Protección de seguridad fija giratoria de plástico "F"
- Estructura de acero pintado o acero inox bajo demanda

- Объем дежи 60 л
- Модель с тремя скоростями или с электронным вариатором скорости посредством инвертера
- Панель управления с сенсорным экраном
- Миксер с подъемом дежи вручную или автоматическим подъемом дежи (по запросу)
- Фиксированная пластиковая защита "F"
- Корпус из окрашенной или нержавеющей стали (по запросу)

Accessori standard - Standard accessories



Vasca
Bowl



Protezione fissa/girevole in plastica "F"
Fixed rotating plastic safety guard "F"



Frusta fili fini
Fine wire whisk

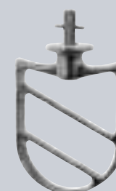

Spatola in alluminio
Aluminium beater



Gancio in alluminio
Aluminium hook

Codice macchina Machine code	Capacità vasca Bowl capacity l	Peso macchina Machine weight kg	Potenza Power kW	Velocità Speed rpm	Voltaggio standard Standard voltage V / PH / Hz	Riduzioni Reduction l
PL60N3F	60	230	0,9 / 1,8 / 2,2	1° 36 (80) 2° 73 (162) 3° 145 (320)	400 / 3 / 50	20 / 40
PL60N3AF	60	230	0,9 / 1,8 / 2,2 + 0,5	1° 36 (80) 2° 73 (162) 3° 145 (320)	400 / 3 / 50	20 / 40
PL60NVF	60	230	3	min. 36 (80) max. 160 (353)	400 / 3 / 50 230 / 1 / 50 - 60	20 / 40
PL60NVAF	60	230	3 + 0,5	min. 36 (80) max. 160 (353)	400 / 3 / 50	20 / 40







» PL80N



PL80N3A



PL80NVA

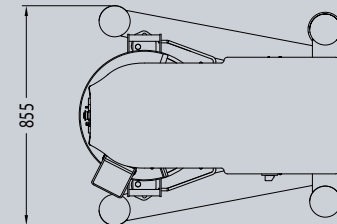
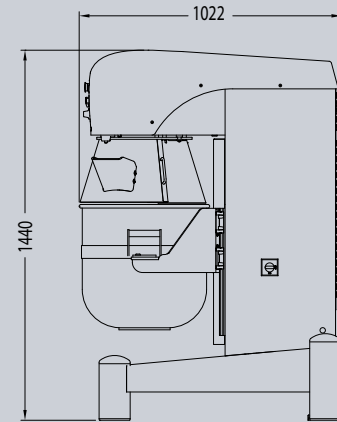

- Capacità vasca 80 litri
- Versioni a 3 velocità o con variatore elettronico di velocità con inverter
- Pannello comandi elettromeccanico
- Sollevamento vasca automatico
- Protezione antinfortunistica fissa/girevole in plastica "F"
- Struttura in acciaio verniciato o in acciaio inox su richiesta

- Bowl capacity 80 liters
- Models by 3 speed or by electronic variable speed by inverter
- Electromechanical control panel
- Automatic bowl lift
- Fixed rotating plastic safety guard "F"
- Structure in painted steel or in stainless steel on request

- Capacité cuve 80 litres
- Modèles par 3 vitesses ou par variateur électronique de vitesse par inverter
- Panneau de commandes électromécanique
- Levage de la cuve automatique
- Protection de sécurité fixe tournant en plastique "F"
- Structure en acier verni ou acier inox sur demande

- Capacidad cuba 80 litros
- Variador electrónico de velocidad con inverter
- Panel de comando electromecánico
- Elevación automático del perol
- Protección de seguridad fija giratoria de plástico "F"
- Estructura de acero pintado o acero inox bajo demanda

- Объем дежи 80 л
- Модель с тремя скоростями или с электронным вариатором скорости посредством инвертера
- Электромеханическая панель управления
- Миксер с автоматической системой поднятия дежи
- Фиксированная пластиковая защита "F"
- Корпус из окрашенной или нержавеющей стали (по запросу)

Accessori standard - Standard accessories



Vasca
Bowl



Protezione fissa/girevole in plastica "F"
Fixed rotating plastic safety guard "F"



Frusta fili fini
Fine wire whisk



Spatola in alluminio
Aluminium beater



Spirale in alluminio
Aluminium spiral

Codice macchina Machine code	Capacità vasca Bowl capacity l	Peso macchina Machine weight kg	Potenza Power kW	Velocità Speed rpm	Voltaggio standard Standard voltage V / PH / Hz	Riduzioni Reduction l
PL80N3AF	80	360	1,2 / 2,5 / 3,1 + 0,75	1° 36 (80) 2° 73 (162) 3° 143 (317)	400 / 3 / 50	40 / 60
PL80NVAF	80	360	4,0 + 0,75	min. 33 (73) max. 150 (333)	400 / 3 / 50	40 / 60



» PL80SN



PL80SN3A



PL80SNVA

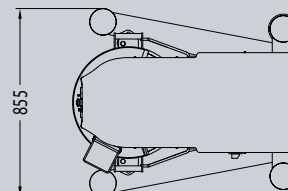
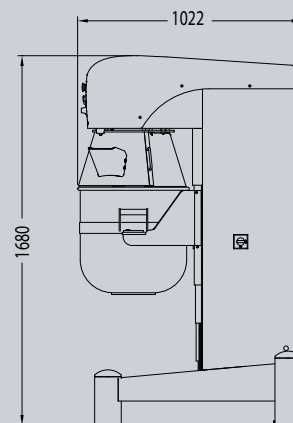

- Capacità vasca 80 litri
- Versioni a 3 velocità o con variatore elettronico di velocità con inverter
- Pannello comandi elettromeccanico
- Sollevamento vasca automatico
- Estrazione vasca senza rimozione utensili
- Protezione antinfortunistica fissa/girevole in plastica "F"
- Struttura in acciaio verniciato o in acciaio inox su richiesta

- Bowl capacity 80 liters
- Models by 3 speed or by electronic variable speed by inverter
- Electromechanical control panel
- Automatic bowl lift
- Removal of the bowl without removing mixing tools
- Fixed rotating plastic safety guard "F"
- Structure in painted steel or in stainless steel on request

- Capacité cuve 80 litres
- Modèles par 3 vitesses ou par variateur électronique de vitesse par inverter
- Panneau de commandes électromécanique
- Levage de la cuve automatique
- Déplacement de la cuve sans déplacer l'outil
- Protection de sécurité fixe tournant en plastique "F"
- Structure en acier peint ou acier inox sur demande

- Capacidad cuba 80 litros
- Variador electrónico de velocidad con inverter
- Panel de comando electromecánico
- Elevación automático del perol
- Extracción del perol sin tener que extraer el utensilio en uso
- Protección de seguridad fija giratoria de plástico "F"
- Estructura de acero pintado o acero inox bajo demanda

- Объем дежи 80 л
- Модель с тремя скоростями или с электронным вариатором скорости посредством инвертера
- Электромеханическая панель управления
- Миксер с автоматической системой поднятия дежи
- Извлечение дежи без снятия насадок
- Фиксированная пластиковая защита "F"
- Корпус из окрашенной или нержавеющей стали (по запросу)

Accessori standard - Standard accessories



Vasca
Bowl



Protezione fissa/girevole in plastica "F"
Fixed rotating plastic safety guard "F"



Frusta fili fini
Fine wire whisk

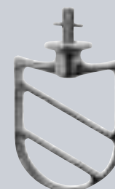

Spatola in alluminio
Aluminium beater



Spirale in alluminio
Aluminium spiral

Codice macchina Machine code	Capacità vasca Bowl capacity l	Peso macchina Machine weight kg	Potenza Power kW	Velocità Speed rpm	Voltaggio standard Standard voltage V / PH / Hz	Riduzioni Reduction l
PL80SN3AF	80	380	1,2 / 2,5 / 3,1 + 0,75	1° 36 (80) 2° 73 (162) 3° 143 (317)	400 / 3 / 50	40 / 60
PL80SNVAF	80	380	4,0 + 0,75	min. 33 (73) max. 150 (333)	400 / 3 / 50	40 / 60



» PL100N



PL100N3A



PL100NVA

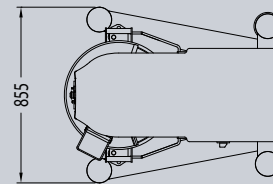
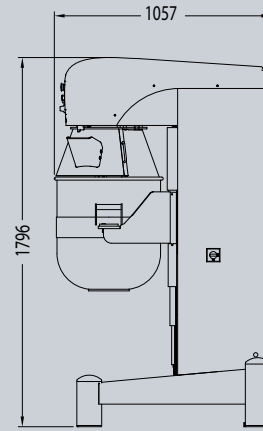

- Capacità vasca 100 litri
- Versioni a 3 velocità o con variatore elettronico di velocità con inverter
- Pannello comandi elettromeccanico
- Sollevamento vasca automatico
- Estrazione vasca senza rimozione utensili
- Protezione antinfortunistica fissa/girevole in plastica "F"
- Struttura in acciaio verniciato o in acciaio inox su richiesta

- Bowl capacity 100 liters
- Models by 3 speed or by electronic variable speed by inverter
- Electromechanical control panel
- Automatic bowl lift
- Removal of the bowl without removing mixing tools
- Fixed rotating plastic safety guard "F"
- Structure in painted steel or in stainless steel on request

- Capacité cuve 100 litres
- Modèles par 3 vitesses ou par variateur électronique de vitesse par inverter
- Panneau de commandes électromécanique
- Levage de la cuve automatique
- Déplacement de la cuve sans déplacer l'outil
- Protection de sécurité fixe tournant en plastique "F"
- Structure en acier verni ou acier inox sur demande

- Capacidad cuba 100 litros
- Variador electrónico de velocidad con inverter
- Panel de comando electromecánico
- Elevación automático del perol
- Extracción del perol sin tener que extraer el utensilio en uso
- Protección de seguridad fija giratoria de plástico "F"
- Estructura de acero pintado o acero inox bajo demanda

- Объем дежи 100 л
- Модель с тремя скоростями или с электронным вариатором скорости посредством инвертера
- Электромеханическая панель управления
- Миксер с автоматической системой поднятия дежи
- Извлечение дежи без снятия насадок
- Фиксированная пластиковая защита "F"
- Корпус из окрашенной или нержавеющей стали (по запросу)

Accessori standard - Standard accessories



Vasca
Bowl



Protezione fissa/girevole in plastica "F"
Fixed rotating plastic safety guard "F"



Frusta fili fini
Fine wire whisk



Spatola in alluminio
Aluminium beater



Spirale in alluminio
Aluminium spiral

Codice macchina Machine code	Capacità vasca Bowl capacity l	Peso macchina Machine weight kg	Potenza Power kW	Velocità Speed rpm	Voltaggio standard Standard voltage V / PH / Hz	Riduzioni Reduction l
PL100N3AF	100	390	1,2 / 2,5 / 3,1 + 0,75	1° 36 (80) 2° 73 (162) 3° 143 (317)	400 / 3 / 50	40 / 60
PL100NVAF	100	390	4,0 + 0,75	min. 33 (73) max. 150 (333)	400 / 3 / 50	40 / 60



» PL120N



PL120NVA

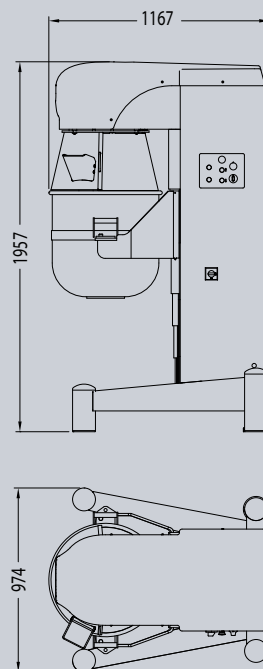

- Capacità vasca 120 litri
- Variatore elettronico di velocità con inverter
- Pannello comandi elettromeccanico
- Sollevamento vasca automatico
- Estrazione vasca senza rimozione utensili
- Protezione antinfortunistica fissa/girevole in plastica "F"
- Struttura in acciaio verniciato o in acciaio inox su richiesta

- Bowl capacity 120 liters
- Electronic variable speed by inverter
- Electromechanical control panel
- Automatic bowl lift
- Removal of the bowl without removing the mixing tools
- Fixed rotating plastic safety guard "F"
- Structure in painted steel or in stainless steel on request

- Capacité cuve 120 litres
- Variateur électronique de vitesse par inverter
- Panneau de commandes électromécanique
- Levage de la cuve automatique
- Déplacement de la cuve sans déplacer l'outil
- Protection de sécurité fixe tournant en plastique "F"
- Structure en acier verni ou acier inox sur demande

- Capacidad cuba 120 litros
- Variador electrónico de velocidad con inverter
- Panel de comando electromecánico
- Elevación automático del perol
- Extracción del perol sin tener que extraer el utensilio en uso
- Protección de seguridad fija giratoria de plástico "F"
- Estructura de acero pintado o acero inox bajo demanda

- Объем дежи 120 л
- Электронный вариатор скорости посредством инвертера
- Электромеханическая панель управления
- Миксер с автоматической системой поднятия дежи
- Извлечение дежи без снятия насадок
- Фиксированная пластиковая защита "F"
- Корпус из окрашенной или нержавеющей стали (по запросу)

Accessori standard - Standard accessories



Vasca
Bowl



Protezione fissa/girevole in plastica "F"
Fixed rotating plastic safety guard "F"



Frusta fili fini
Fine wire whisk



Spatola in alluminio
Aluminium beater



Spirale in alluminio
Aluminium spiral

Codice macchina Machine code	Capacità vasca Bowl capacity l	Peso macchina Machine weight kg	Potenza Power kW	Velocità Speed rpm	Voltaggio standard Standard voltage V / PH / Hz	Riduzioni Reduction l
PL120NVAF	120	575	5,5 + 0,75	min. 28 (62) max. 120 (265)	400 / 3 / 50	/



» PL140N



PL140NVA

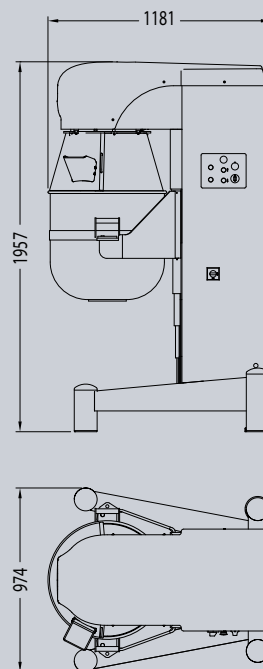

- Capacità vasca 140 litri
- Variatore elettronico di velocità con inverter
- Pannello comandi elettromeccanico
- Sollevamento vasca automatico
- Estrazione vasca senza rimozione utensili
- Protezione antinfortunistica fissa/girevole in plastica "F"
- Struttura in acciaio verniciato o in acciaio inox su richiesta

- Bowl capacity 140 liters
- Electronic variable speed by inverter
- Electromechanical control panel
- Automatic bowl lift
- Removal of the bowl without removing the mixing tools
- Fixed rotating plastic safety guard "F"
- Structure in painted steel or in stainless steel on request

- Capacité cuve 140 litres
- Variateur électronique de vitesse par inverter
- Panneau de commandes électromécanique
- Levage de la cuve automatique
- Déplacement de la cuve sans déplacer l'outil
- Protection de sécurité fixe tournant en plastique "F"
- Structure en acier verni ou acier inox sur demande

- Capacidad cuba 140 litros
- Variador electrónico de velocidad con inverter
- Panel de comando electromecánico
- Elevación automático del perol
- Extracción del perol sin tener que extraer el utensilio en uso
- Protección de seguridad fija giratoria de plástico "F"
- Estructura de acero pintado o acero inox bajo demanda

- Объем дежи 140 л
- Электронный вариатор скорости посредством инвертера
- Электромеханическая панель управления
- Миксер с автоматической системой поднятия дежи
- Извлечение дежи без снятия насадок
- Фиксированная пластиковая защита "F"
- Корпус из окрашенной или нержавеющей стали (по запросу)

Accessori standard - Standard accessories



Vasca
Bowl



Protezione fissa/girevole in plastica "F"
Fixed rotating plastic safety guard "F"



Frusta fili fini
Fine wire whisk



Spatola in alluminio
Aluminium beater



Spirale in alluminio
Aluminium spiral

Codice macchina Machine code	Capacità vasca Bowl capacity l	Peso macchina Machine weight kg	Potenza Power kW	Velocità Speed rpm	Voltaggio standard Standard voltage V / PH / Hz	Riduzioni Reduction l
PL140NVAF	140	595	5,5 + 0,75	min. 28 (62) max. 120 (265)	400 / 3 / 50	/



» Accessori optional - Optional accessories



Codice macchina Machine code	Protezione amovibile in plastica "R"*	Protezione in griglia in acciaio inox "G" ** (solo per paesi extra CE) (only for non EU countries)	Frusta a fili grossi Heavy wire whisk	Spatola in acciaio inox Stainless steel beater	Gancio in acciaio inox Stainless steel hook	Spirale in alluminio Aluminium spiral
PL20BNH - PL20BN	■	✓	✓	✓	✓	✓
PL20CNH - PL20CN	■	✓	✓	✓	✓	✓
PL30NH - PL30N	✓	✓	✓	✓	✓	✓
PL40NH - PL40N	✓	✓	✓	✓	✓	✓
PL60NH - PL60N	✓	✓	✓	✓	✓	✓
PL80NH - PL80N	✓	✓	✓	✓	■	+
PL80SNH - PL80SN	✓	✓	✓	✓	■	+
PL100NH - PL100N	✓	✓	✓	✓	■	+
PL120NP - PL120N	✓	✓	✓	✓	■	+
PL140NP - PL140N	✓	✓	✓	✓	■	+

✓ Optional su richiesta _ Optional on request

■ Non disponibile _ Not available

+ Dotazione standard _ Standard equipment

* Per ordinare una mescolatrice planetaria con protezione amovibile in plastica anziché fissa/girevole sostituire nel codice macchina la sigla "F" (fissa/girevole) con la sigla "R" (amovibile)

** Per ordinare una mescolatrice planetaria con protezione in griglia in acciaio inox anziché fissa/girevole sostituire nel codice macchina la sigla "F" (fissa/girevole) con la sigla "G" (griglia)

Attenzione!
in conformita' all'ultima revisione della norma "European standard en 454" del 2015, la macchina dotata di questa protezione in griglia **non potrà essere marchiata "CE"**

* To order a planetary mixer equipped with the removable plastic safety guard instead of the fixed rotating plastic guard, you have to substitute in its code the letter "F" (fixed/rotating) by the letter "R" (removable)

** To order a planetary mixer equipped with the stainless steel grid guard instead of the fixed rotating plastic safety guard, you have to substitute in its code the letter "F" (fixed/rotating) by the letter "G" (grid)

Attention!
in compliance with the last revision of "European standard en 454" of 2015, planetary mixer equipped with this grid guard **can't be marked "CE"**



Codice macchina Machine code	Spirale in acciaio inox Stainless steel spiral	Carrello vasca Bowl support trolley	Attacco raschiatore Scraper attachment	Raschiatore Scraper	Carrello vasca Bowl support trolley	Kit riduzione Kit reduction
PL20BNH - PL20BN	✓	■	■	■	■	✓
PL20CNH - PL20CN	✓	■	■	■	■	✓
PL30NH - PL30N	✓	✓	■	■	■	■
PL40NH - PL40N	✓	✓	✓	✓	■	✓
PL60NH - PL60N	✓	✓	✓	✓	■	✓
PL80NH - PL80N	✓	■	✓	✓	✓	✓
PL80SNH - PL80SN	✓	■	✓	✓	✓	✓
PL100NH - PL100N	✓	■	✓	✓	✓	✓
PL120NP - PL120N	✓	■	✓	✓	✓	■
PL140NP - PL140N	✓	■	✓	✓	✓	■



» Note - Notes

A series of horizontal lines for writing, spanning the width of the page below the title.





125424, г. Москва, Волоколамское шоссе, д. 88, стр. 8
Тел./факс: +74955404600

РУССКИЙ ПРОЕКТ
WWW.RP.RU